

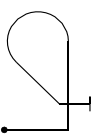

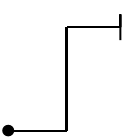

2019		Form A
Pilot ID	NZAC Intermediate Known	Flight #

No	Symbol	Cat. No.	K	Total K	Marks	Remarks	Pos	Item	K	Grade
1		8.5.17.1	12	12				Pos.	20	
								Harm.	0	
2		1.1.6.1	10	10				Fig K	Total K	
								182	202	
3		1.1.6.3 9.11.1.6	10 3	13				Penalties		
								Too Low		
4		1.2.3.1 9.4.2.2	12 7	19				Too High		
								Interruptions		
5		7.4.1.1 9.9.3.4	10 11	21				Insertions		
								Trg Violation		
6		5.2.1.1 9.1.1.1 9.1.5.2	17 6 4	27				Wing Rocks		
								Disqual Fig		
7		8.4.1.1 9.1.5.1	13 2	15				Final Freestyle		
								Other(note...)		
8		1.2.7.1 9.1.4.2	13 4	17				Duration	Min	Sec
9		7.2.1.1 9.1.3.4	6 8	14				Judges Details		
								Signature		
10		8.5.4.4 9.1.4.2 9.4.3.2	11 4 5	20				Name		
								Number		
11		2.1.3.1	14	14						

Pilot

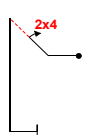
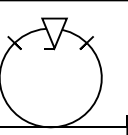
A/C

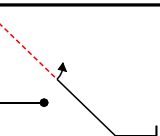
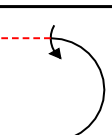
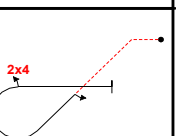
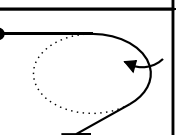
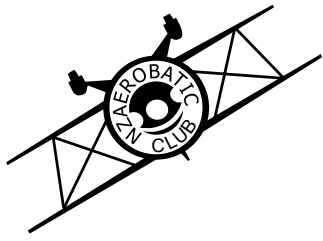

2019		Form B
Pilot ID	NZAC Intermediate Known	Flight #

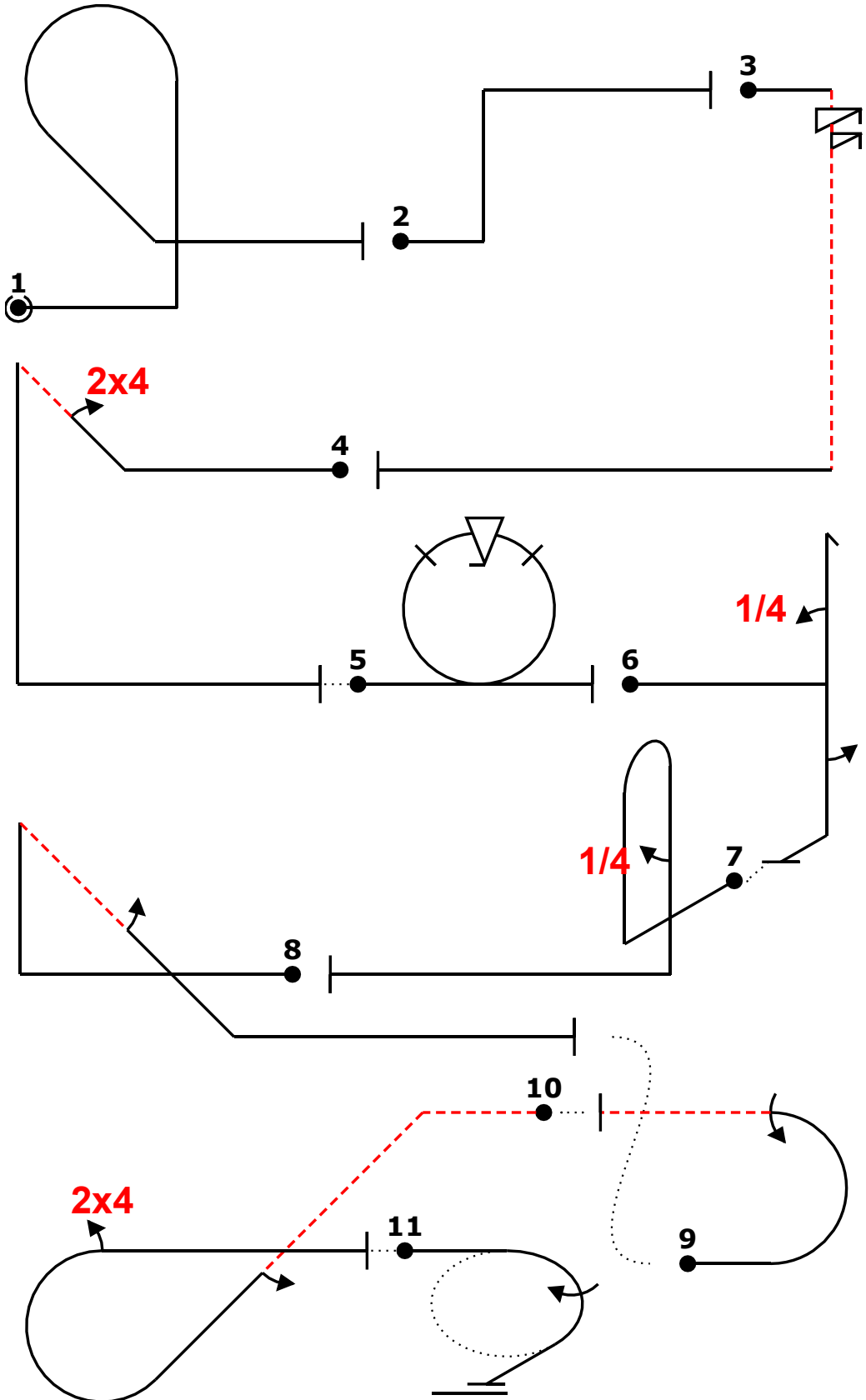
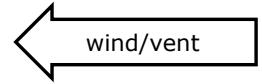

Power			
Fig 1	8.5.17.1	12	12
Fig 2	1.1.6.1	10	10
Fig 3	1.1.6.3 9.11.1.6	10 3	13
Fig 4	1.2.3.1 9.4.2.2	12 7	19
Fig 5	7.4.1.1 9.9.3.4	10 11	21
Fig 6	5.2.1.1 9.1.1.1 9.1.5.2	17 6 4	27
Fig 7	8.4.1.1 9.1.5.1	13 2	15
Fig 8	1.2.7.1 9.1.4.2	13 4	17
Fig 9	7.2.1.1 9.1.3.4	6 8	14
Fig 10	8.5.4.4 9.1.4.2 9.4.3.2	11 4 5	20
Fig 11	2.1.3.1	14	14
Total K = 182			

_____ Pilot
 A/C

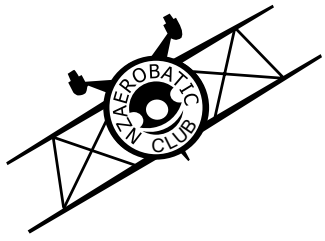

2019		Form C
Pilot ID	NZAC Intermediate Known	
	Flight #	

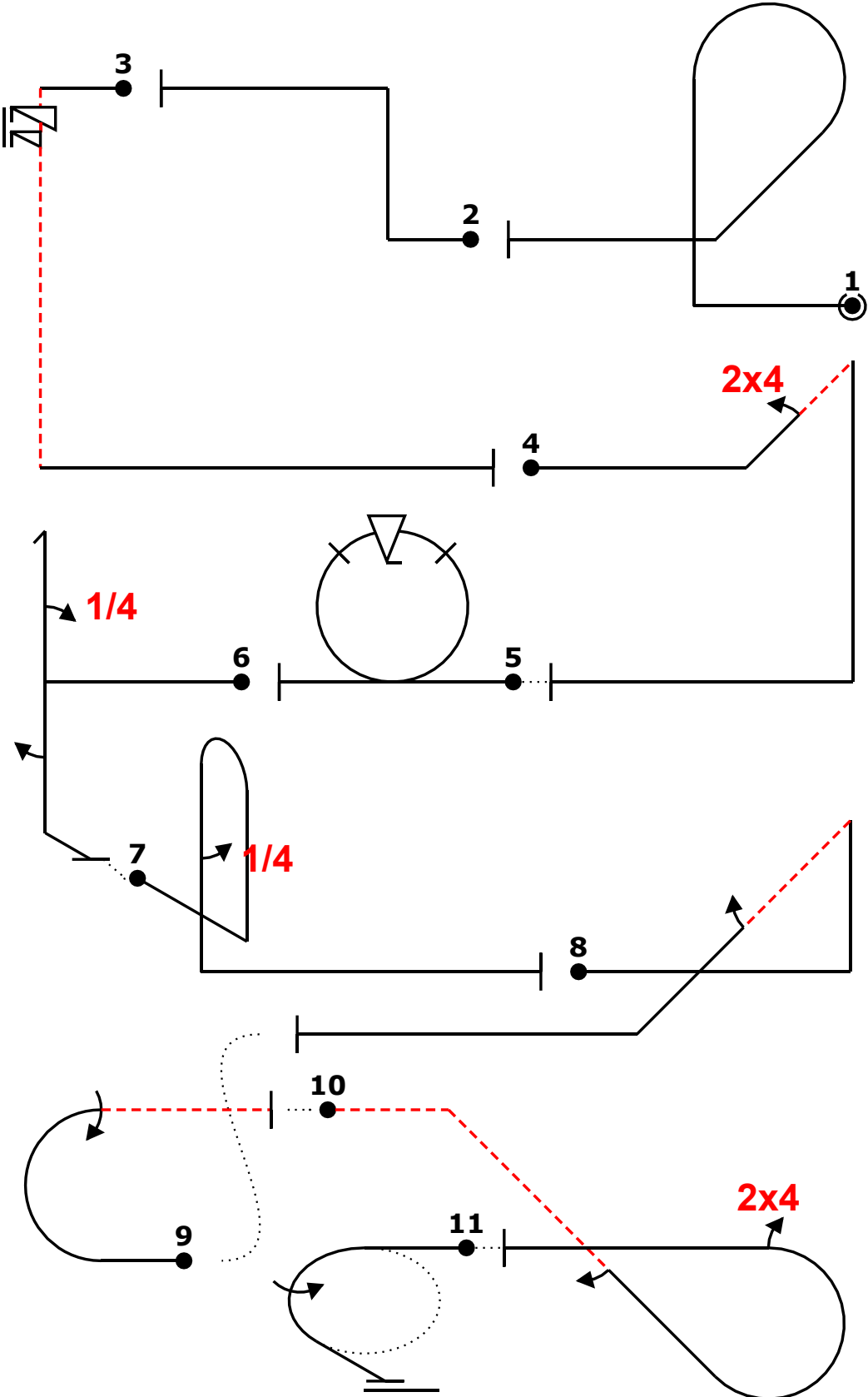
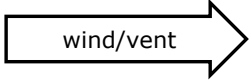

Pilot
A/C

