

2020		Form A
Pilot ID	NZAC Advanced Known	Flight #

No	Symbol	Cat. No.	K	Total K	Grade	Pos	Remarks	Item	K	Grade
1		1.3.2.1 9.1.2.6 9.1.2.4	18	40	.			Pos.	30	
			12					Harm.	0	
			10	SF 7						
2		7.2.2.3 9.1.3.1 9.1.3.3	8	16	.			Fig K		Total K
			2					284	314	
			6	SF 7				Penalties		
3		8.8.1.1 9.8.1.1 9.9.5.3	18	36	.			Too Low		
			7					Too High		
			11	SF 4				Interruptions		
4		1.3.11.4 9.12.1.4 9.9.2.2	20	40	.			Insertions		
			7					Trg Violation		
			13	SF 3				Wing Rocks		
5		5.3.2.1 9.4.2.2 9.9.5.2	24	42	.			Disqual Fig		
			7					Other(note...)		
			11	SF 4				Final Freestyle		
6		7.5.7.1 9.8.4.2 9.1.3.6	15	32	.			Duration		
			7					Min	Sec	
			10	SF 7				Judges Details		
7		2.3.4.3	33	33	.			Signature		
								Name		
				SF 2				Number		
8		8.4.1.1 9.1.5.3	13	19	.					
			6							
				SF 7						
9		7.2.1.1 9.2.3.4 9.4.3.4	6	26	.					
			9							
			11	SF 7						

Pilot

A/C

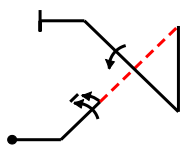
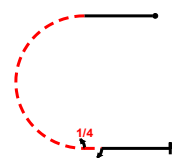
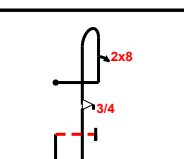
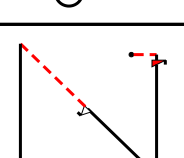
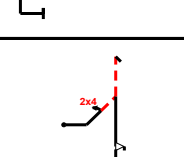
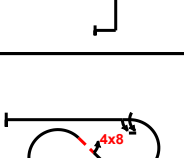
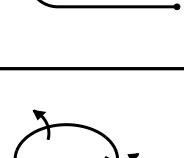
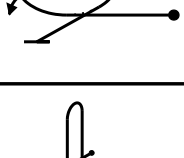
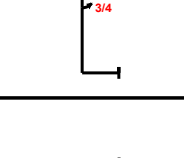
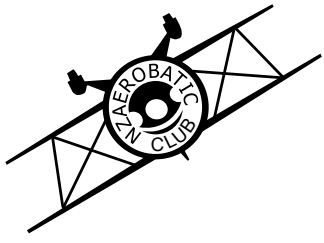

2020		Form B
Pilot ID	NZAC Advanced Known	
		Flight #

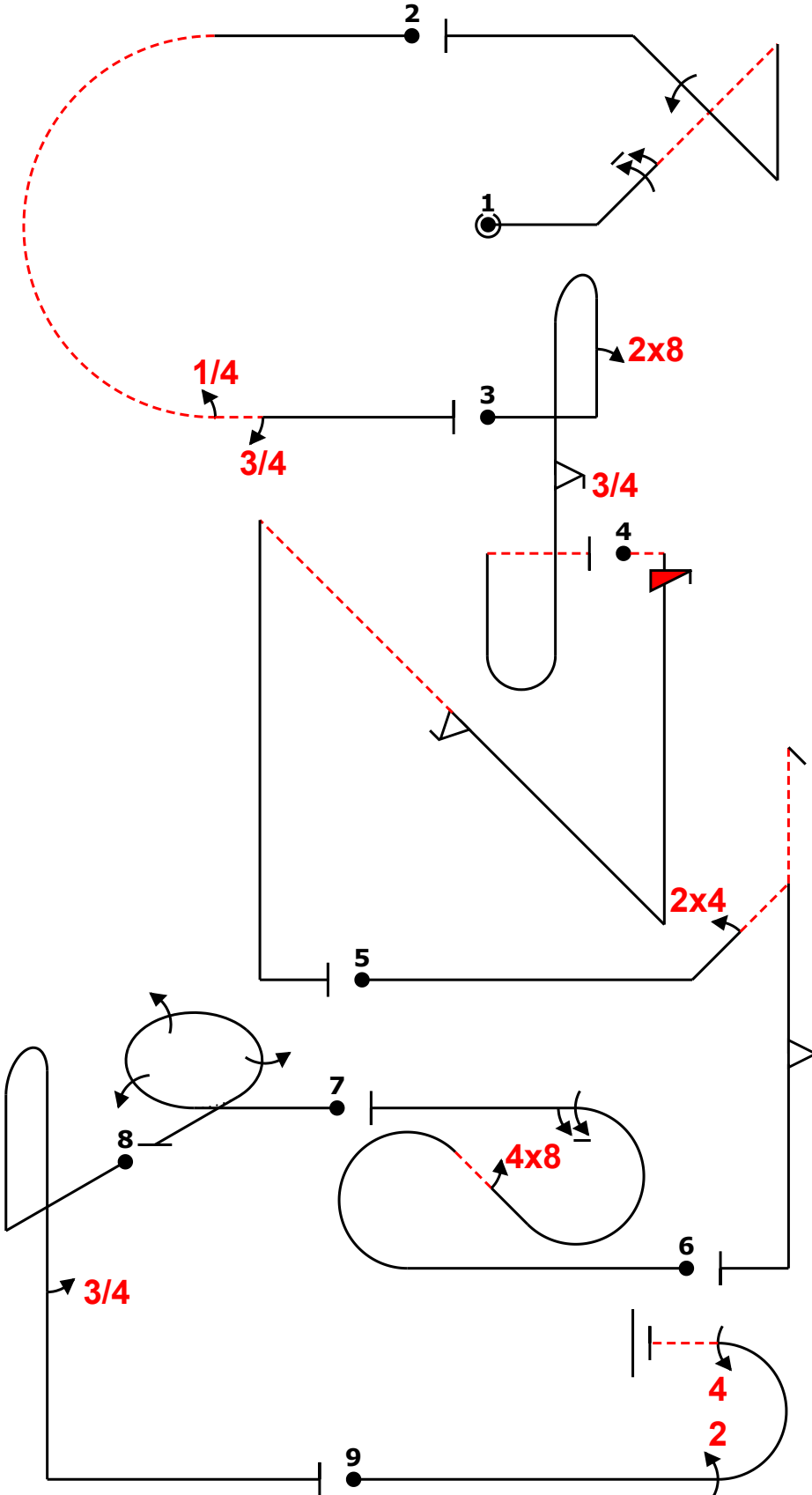
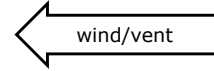

Power			
Fig	Aresti	K	
1	1.3.2.1	18	40
	9.1.2.6	12	
	9.1.2.4	10	
2	7.2.2.3	8	16
	9.1.3.1	2	
	9.1.3.3	6	
3	8.8.1.1	18	36
	9.8.1.1	7	
	9.9.5.3	11	
4	1.3.11.4	20	40
	9.12.1.4	7	
	9.9.2.2	13	
5	5.3.2.1	24	42
	9.4.2.2	7	
	9.9.5.2	11	
6	7.5.7.1	15	32
	9.8.4.2	7	
	9.1.3.6	10	
7	2.3.4.3	33	33
8	8.4.1.1	13	19
	9.1.5.3	6	
9	7.2.1.1	6	26
	9.2.3.4	9	
	9.4.3.4	11	
Total K = 284			

Pilot
A/C

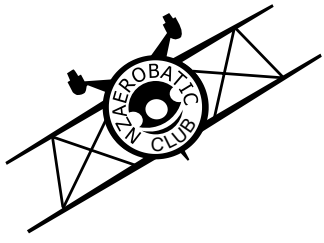

2020		Form C
Pilot ID	NZAC Advanced Known	Flight #

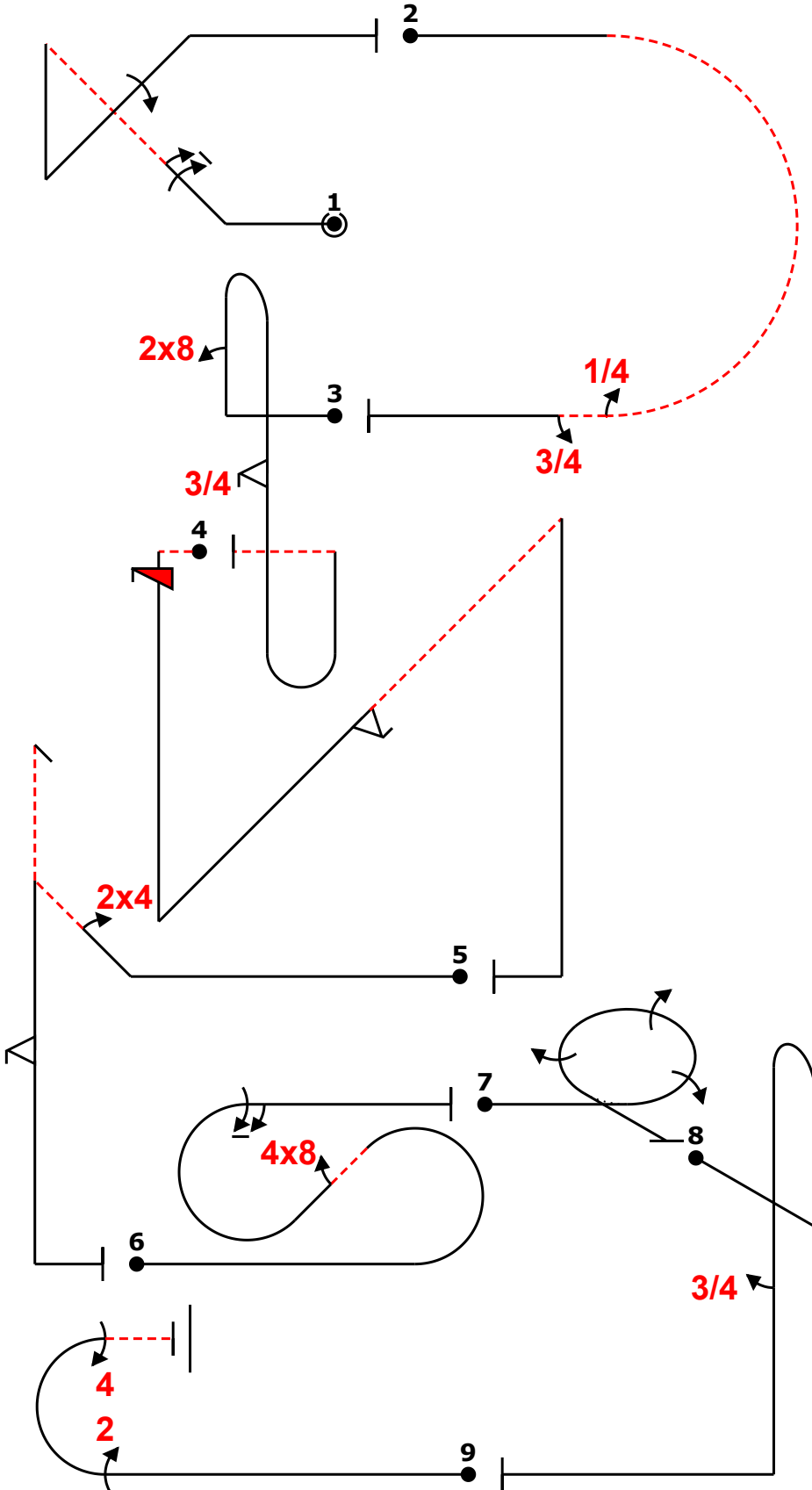
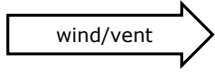

Pilot
A/C