

Form A	
Pilot ID	2021/2022 NZAC Advanced Known
Flight #	

No	Symbol	Cat. No.	K	Total K	Grade	Pos	Remarks	Item	K	Grade
1		<b>8.6.1.1</b> <b>9.1.1.1</b> <b>9.1.3.4</b> <b>9.1.3.3</b> <b>9.4.3.3</b>	11	39	.			Pos.	25	
			Harm.					0		
2		<b>5.2.1.1</b> <b>9.8.1.1</b> <b>9.9.5.3</b>	17	35	.			Fig K		Total K
			288					313		
3		<b>1.3.4.1</b> <b>9.1.2.1</b> <b>9.1.2.3</b> <b>9.1.2.2</b>	18	36	.			<b>Penalties</b>		
			4							
4		<b>8.6.5.4</b> <b>9.1.3.4</b>	12	20	.			<b>Final Freestyle</b>		
			8							
5		<b>1.3.11.4</b> <b>9.12.1.4</b> <b>9.9.2.2</b>	20	40	.			Duration	Min	Sec
6		<b>8.5.11.1</b> <b>9.4.2.2</b> <b>9.8.5.1</b>	17	27	.			<b>Judges Details</b>		
			7							
7		<b>8.4.3.1</b> <b>9.1.1.1</b> <b>9.1.5.2</b>	15	25	.					
			6							
8		<b>7.2.3.1</b> <b>9.4.3.2</b> <b>9.2.3.4</b> <b>9.9.3.4</b>	8	33	.					
			5							
9		<b>2.3.4.3</b>	33	33	.					
			4							

\_\_\_\_\_ Pilot  
 \_\_\_\_\_ A/C

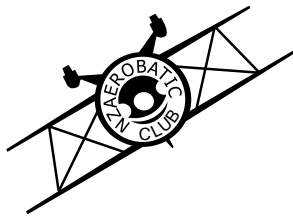

		Form B
Pilot ID	2021/2022 NZAC Advanced Known	Flight #

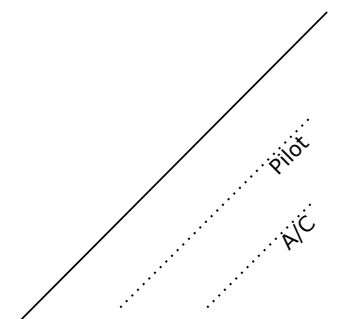
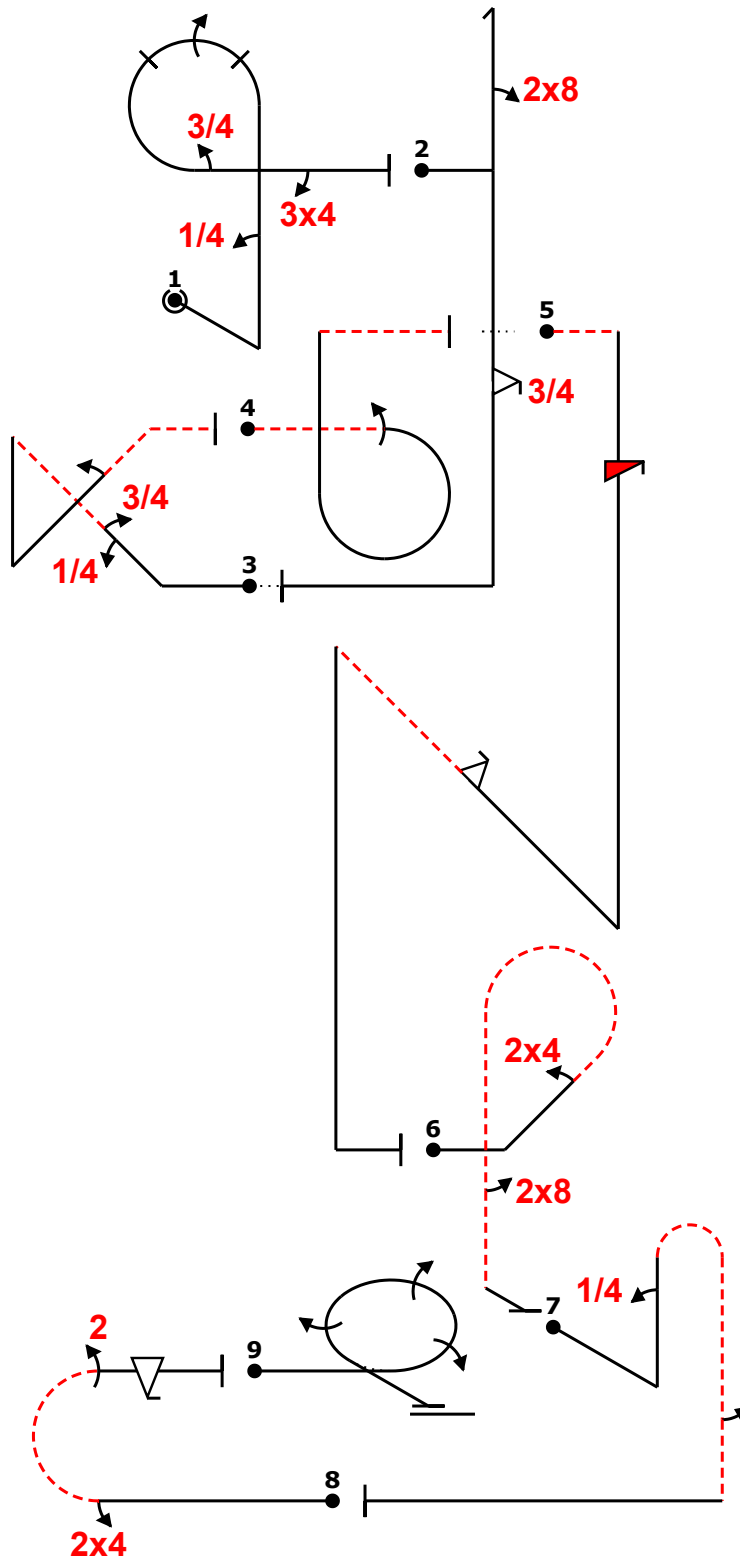
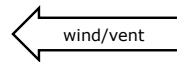

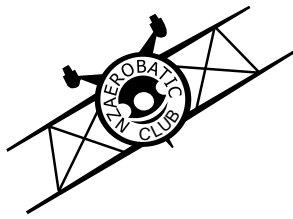

		Form C
Pilot ID	2021/2022 NZAC Advanced Known	Flight #

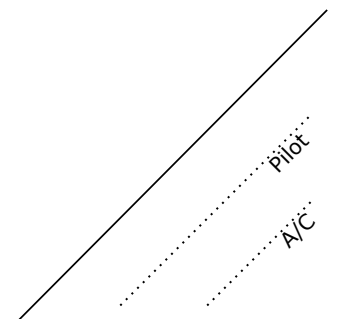
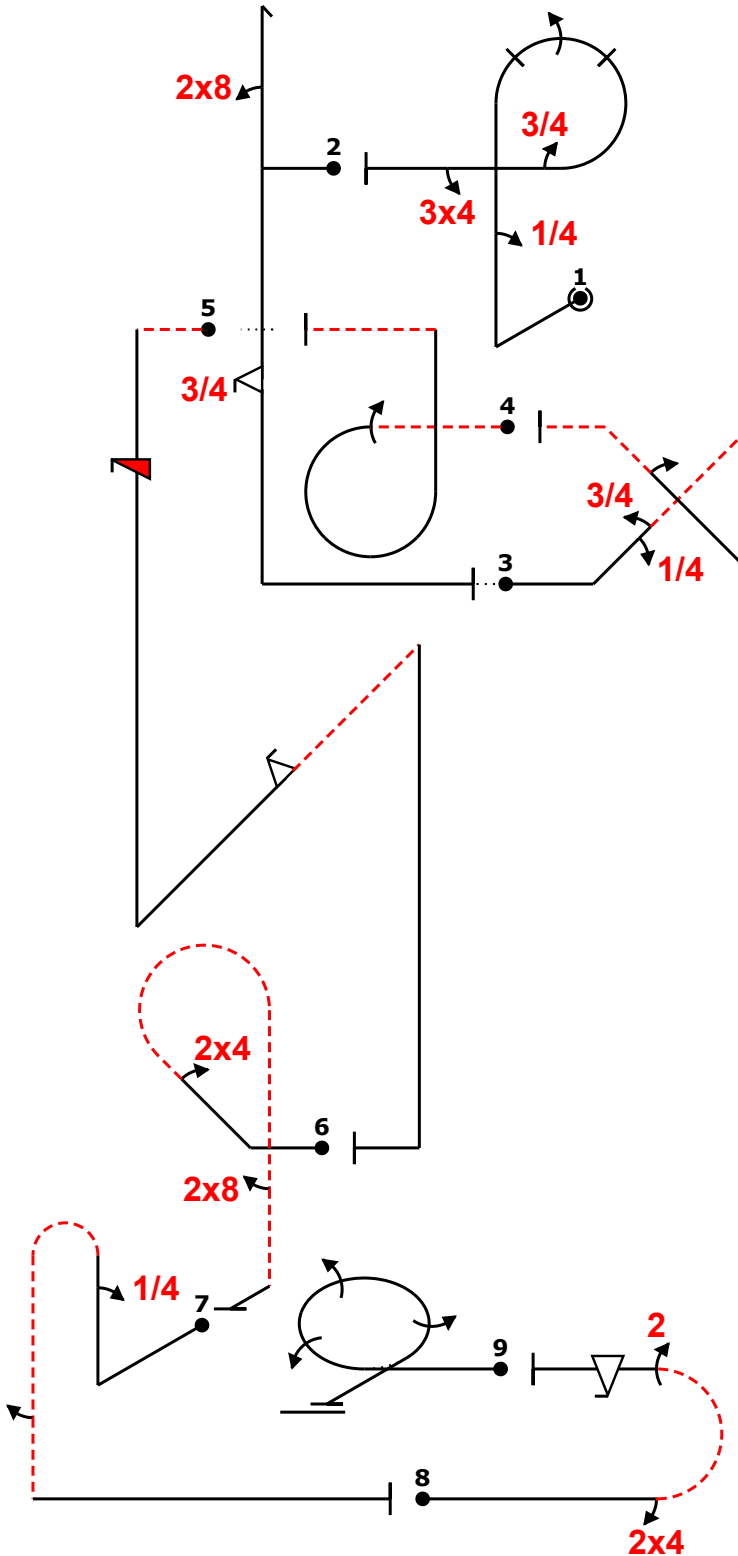
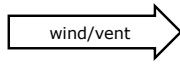

wind/vent

