

Form A	
Pilot ID	2021/2022 NZAC Primary Known
Flight #	

No	Symbol	Cat. No.	K	Total K	Grade	Pos	Remarks	Item	K	Grade
1		1.1.2.1	7	7	.			Pos.	3	
2		1.1.6.3 9.11.1.4	10 5	15	.			Fig K	73	Total K
Penalties										
								Too Low		
								Too High		
								Interruptions		
								Insertions		
								Trg Violation		
								Wing Rocks		
								Disqual Fig		
								Other(note...)		
Final Freestyle										
								Duration	Min	Sec
Judges Details										
								Signature		
								Name		
								Number		
3		8.5.6.1 9.1.4.2	10 4	14	.					
4		7.4.1.1	10	10	.					
5		5.2.1.1	17	17	.					
6		1.1.1.1 9.1.3.4	2 8	10	.					

_____ Pilot
 A/C

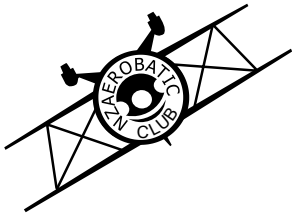

		Form B
Pilot ID	2021/2022 NZAC Primary Known	Flight #

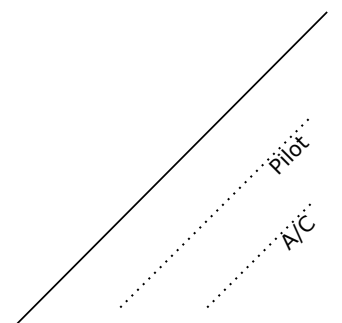
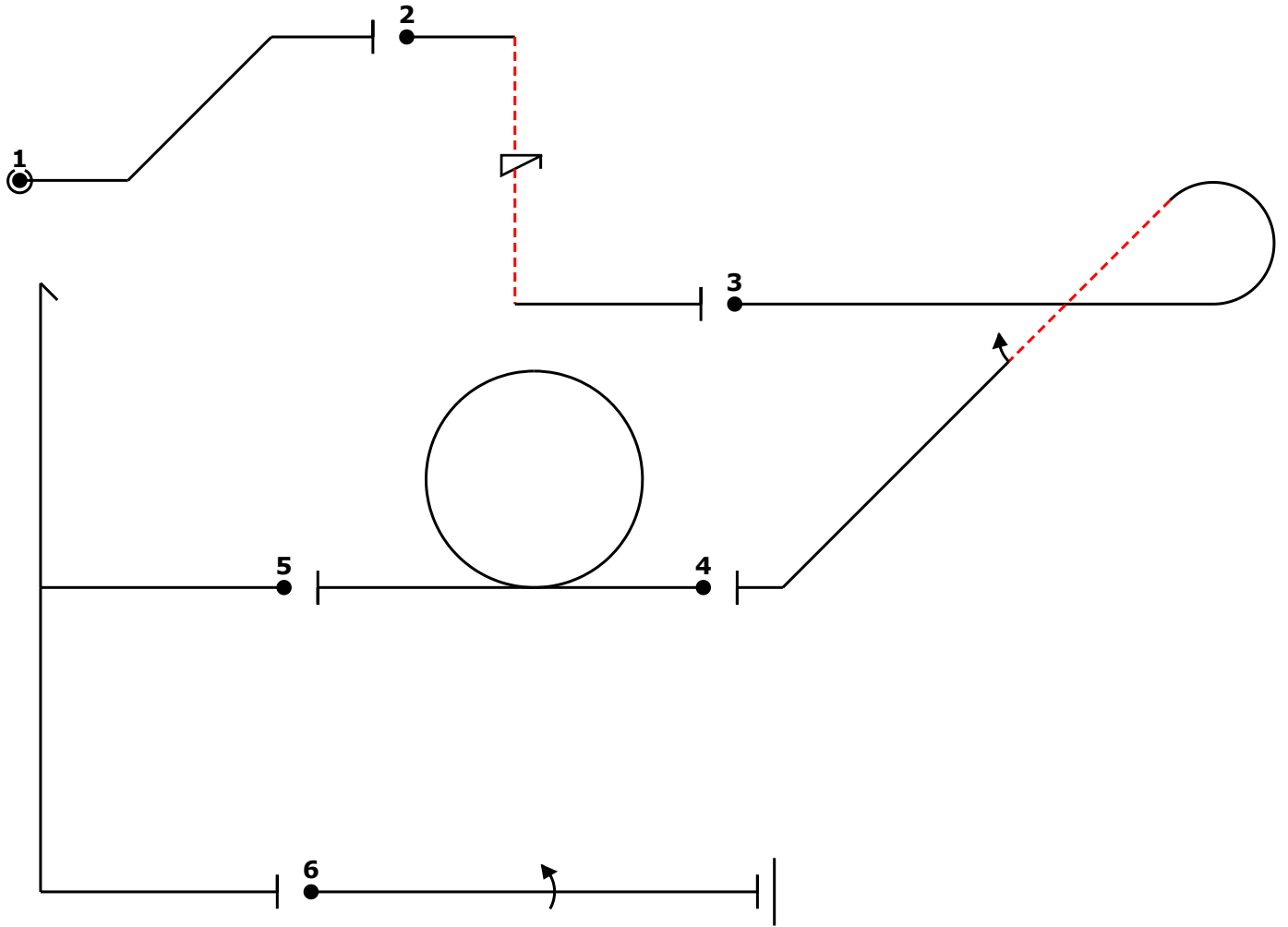
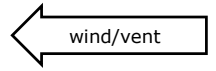

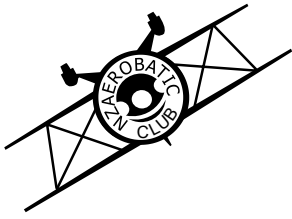

		Form C
Pilot ID	2021/2022 NZAC Primary Known	Flight #

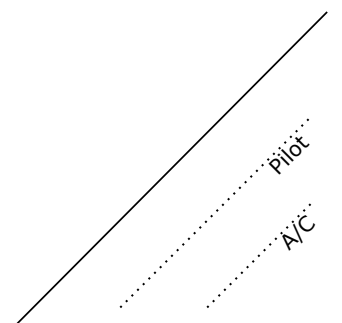
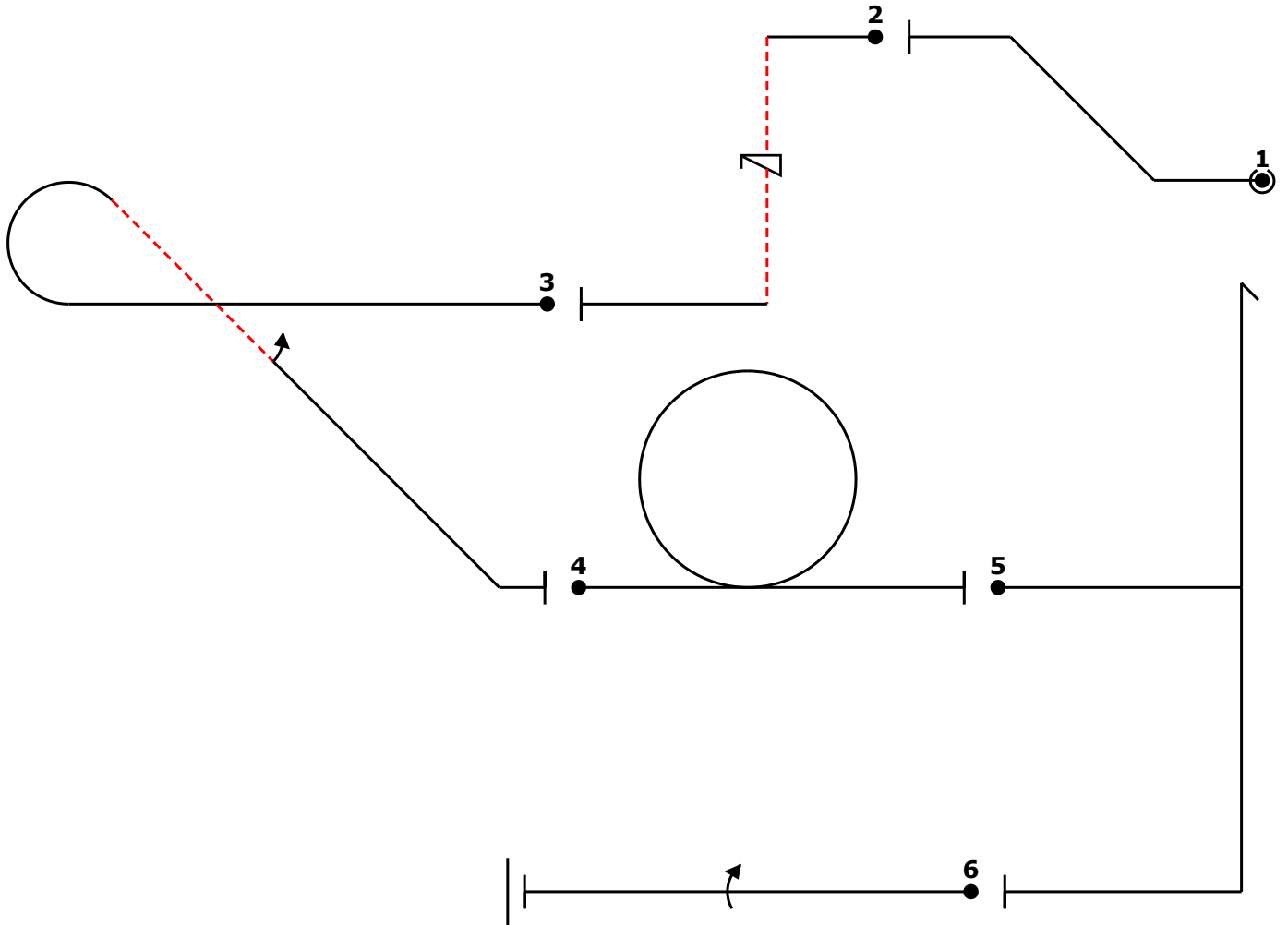
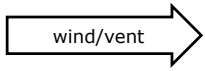

wind/vent

